

RAPIER

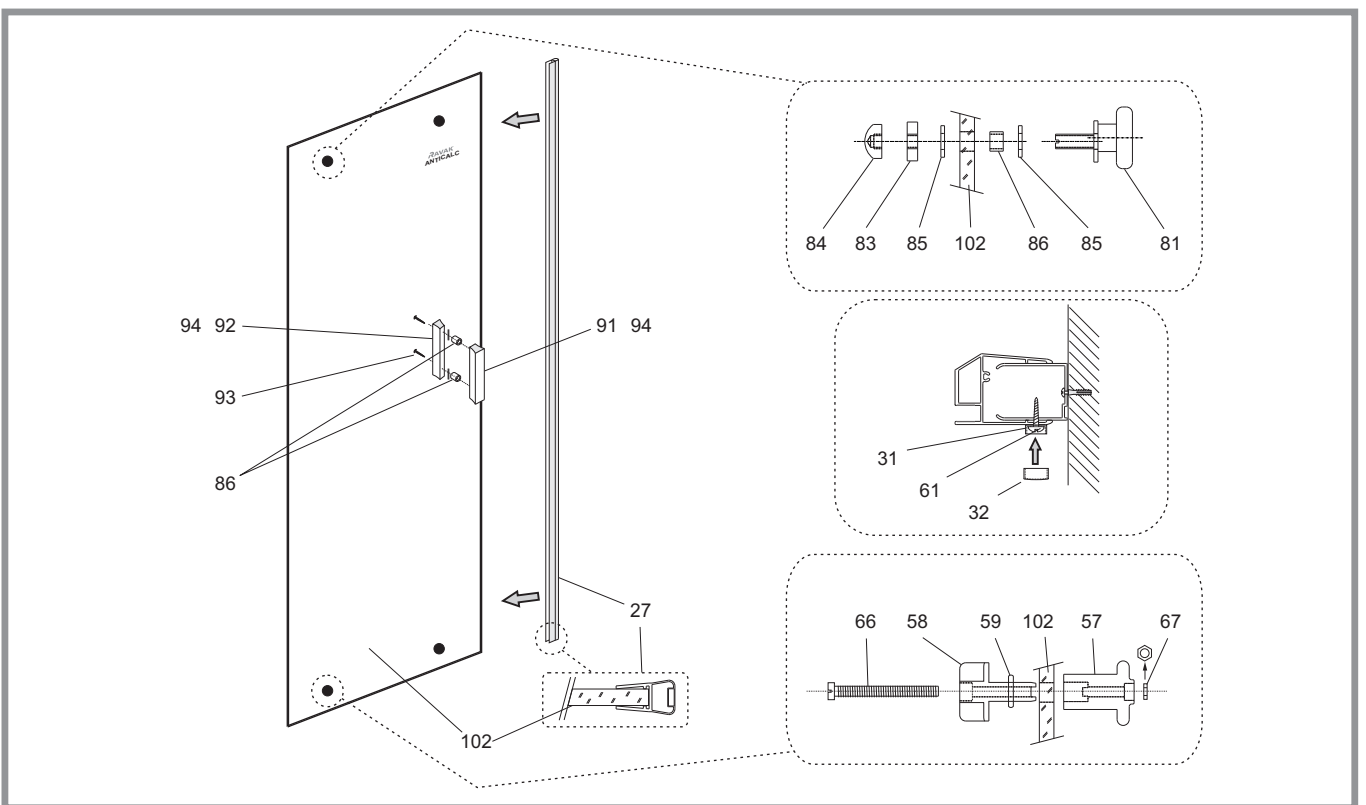

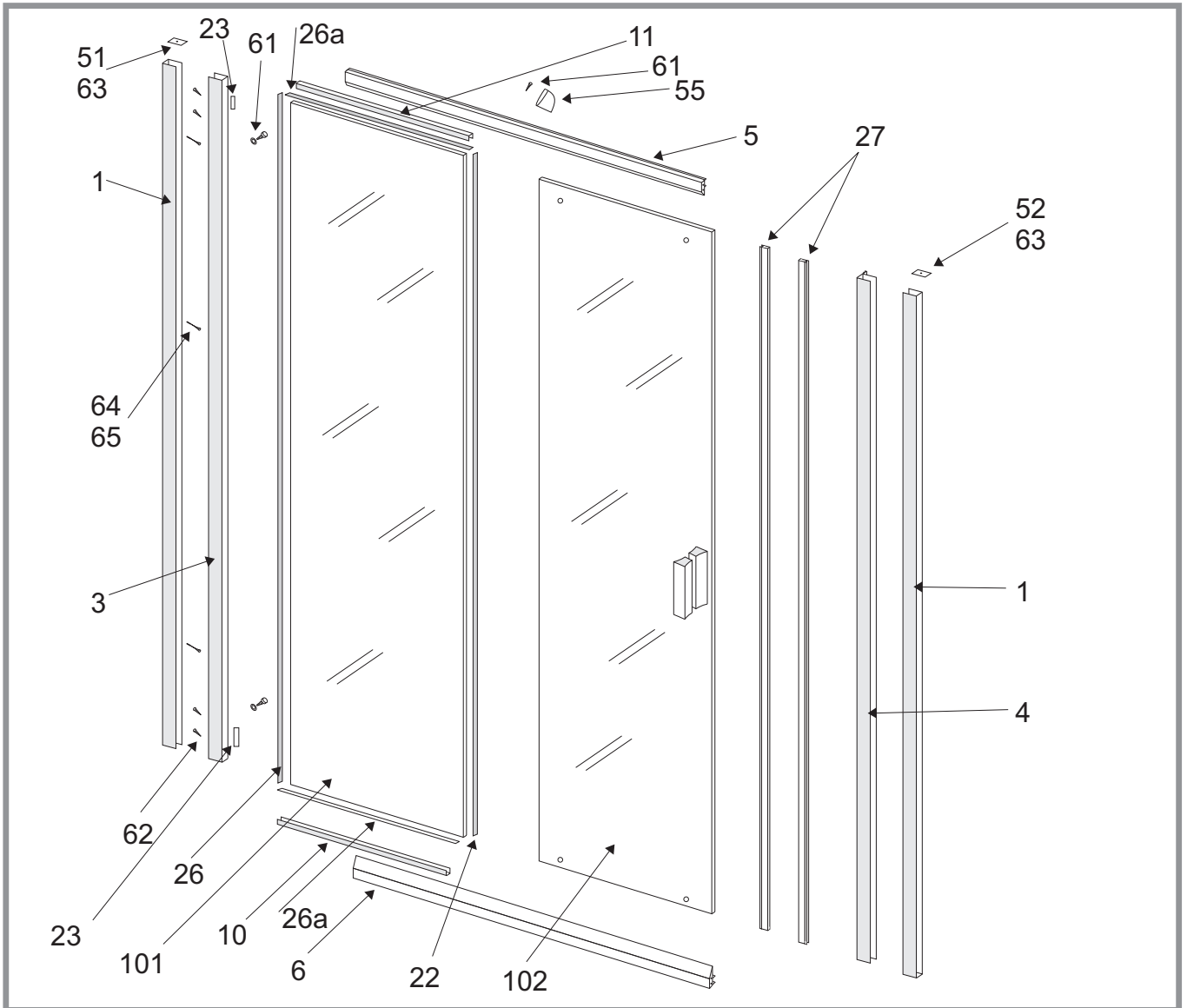

















Katalog dílů
Platnost od 08/2012

RAVAK®



















RAPIER RDP2 - 100,110,120 - SATIN

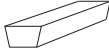
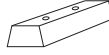

RAPIER RDP2 - 100,110,120 - SATIN

Číslo dílu	Název dílu	Rozměr mm	Pro rozměr výrobku	SIČ	Typový díl pro všechny rozměry SIČ	
1	„U“ profil přímý	dl. 1900			XVRA0501X1900	
3	Svislý profil PD	dl. 1900			XVRA0301X1900	
4	Svislý profil D2	dl. 1900			XVRA0402X1900	
5	Vodící profil	dl. 858	RDP2-100	XVRA0109X0858		
		dl. 958	RDP2-110	XVRA0111X0958		
		dl. 1058	RDP2-120	XVRA0113X1058		
6	Vodící profil	dl. 858	RDP2-100	XVRA0110X0858		
		dl. 958	RDP2-110	XVRA0112X0958		
		dl. 1058	RDP2-120	XVRA0114X1058		
10	Lem skla	dl. 403	RDP2-100	XVRA0901X0403		
		dl. 453	RDP2-110	XVRA0903X0453		
		dl. 503	RDP2-120	XVRA0905X0503		
11	Lem skla	dl. 403	RDP2-100	XVRA0902X0403		
		dl. 453	RDP2-110	XVRA0904X0453		
		dl. 503	RDP2-120	XVRA0906X0503		
22	Svislý těsnící profil 89	dl. 1800			X88900000000	
23	Profil měkk. dorazu 91	dl. 133			X89100000000	
26	Zasklívací profil 90	dl. 1815			X89000000000	
26a	Zasklívací profil 111	dl. 1200			X8B100000000	
27	Magnetický profil přímý	dl. 1882			X6C124600170	
27	Magnetický profil přímý	dl. 1900			X6C124600160	
31	Podložka krytky 106	Ø 11			X8A600000000	
32	Krytka šedá	Ø 11			X8A500000000	
33	Záslepka	Ø 10			X80001100100	
51	Krytka ustav. profilu 78A				X878A0000000	
52	Krytka ustav. profilu 78B				X878B0000000	
55	Koncovka 84A				X884A0000000	
56	Koncovka 84B				X884B0000000	

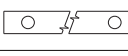

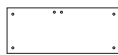
RAPIER RDP2 - 100,110,120 - SATIN

Číslo dílu	Název dílu	Rozměr mm	Pro rozměr výrobku	SIČ	Typový díl pro všechny rozměry SIČ	
57	Vodící háček 82				X88200000000	
58	Knoflík háčku 83				X88300000000	
59	„O“ kroužek	Ø16 x 2			X89000000004	
61	Šroub samoř.DIN 7981	Ø 3,5 x 13			X97981035130	
62	Šroub samoř.DIN 7981	Ø 3,5 x 25			X97981035250	
63	Šroub samoř.DIN7982	Ø 3,5 x 13			X97982035130	
64	Vrut do hmoždinky	Ø4 x 40			X94000040400	
65	Hmoždinka	Ø 8			X20600080000	
66	Šroub nerez DIN 84	M 4 x 30			X90084040300	
67	Matice nerez/mosaz	M 4			X93000040025	
81	Ložisk. pojezd RAPIER	Jednoduchý			X3C0240304016	
83	Matice chrom	M 6 x 4			X3C0RAD02001A	
84	Krytka chrom	M 6 x 7			X3C0RAD02002A	
85	Podložka kolečka č.87	Ø12,8x1,5			X88700000000	
86	Průchodka 88	Ø 7,7x5,5			X88800000000	
91	Madlo RAPIER vnější Cr	dl. 165			XVB01601A0165	
92	Madlo RAPIER vnitřní Cr	dl. 165			XVB01602A0165	
93	Šroub DIN 964 nerez	M 4 x 35			X90964040350	
94	Podložka madla RAPIER				X3C0RAD030010	
101	Sklo PS tl. 6 mm	1815x397	RDP2-100	X4Z160I15397		
		1815x447	RDP2-110	X4Z160I15447		
		1815x497	RDP2-120	X4Z160I15497		
102	Sklo dveří tl. 6 mm	1882x478	RDP2-100	X4Z160I82478		
		1882x528	RDP2-110	X4Z160I82528		
		1882x578	RDP2-120	X4Z160I82578		

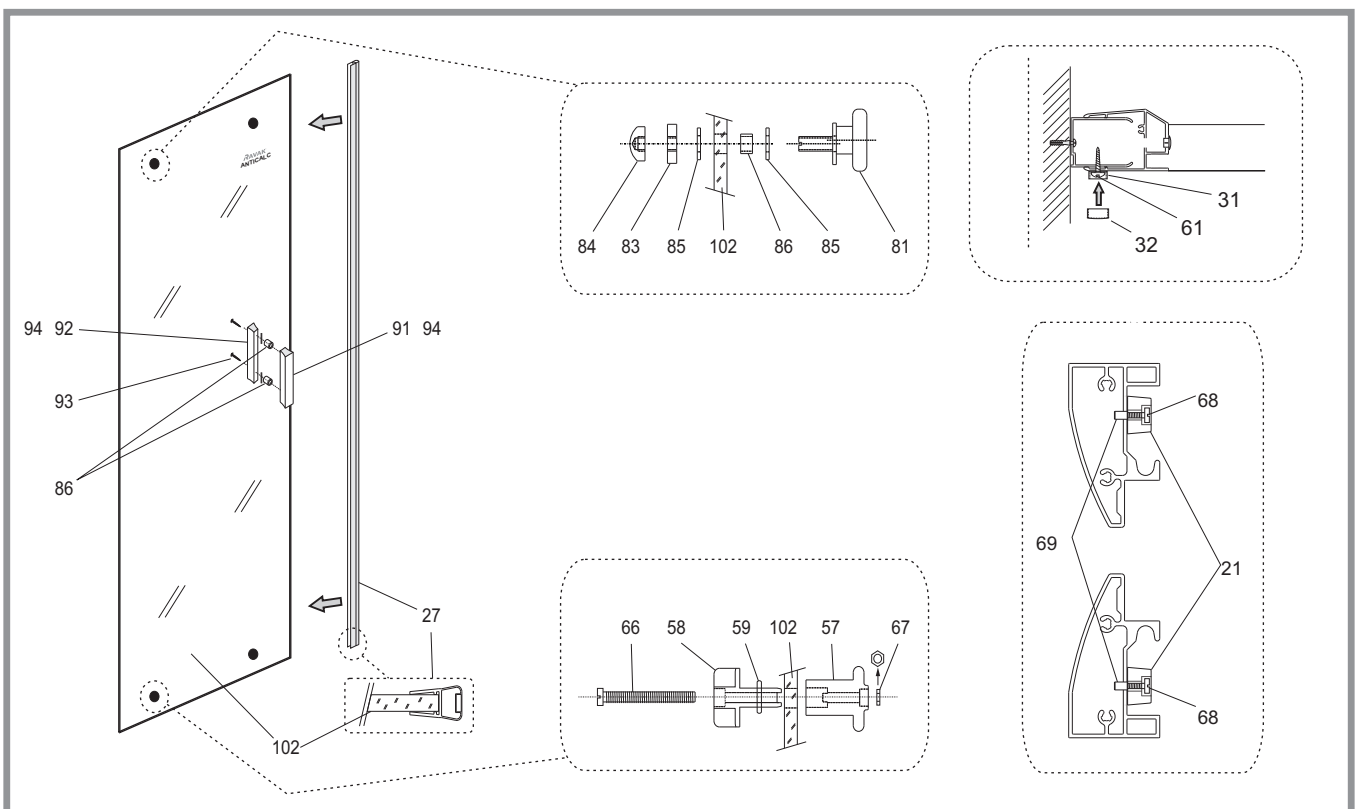
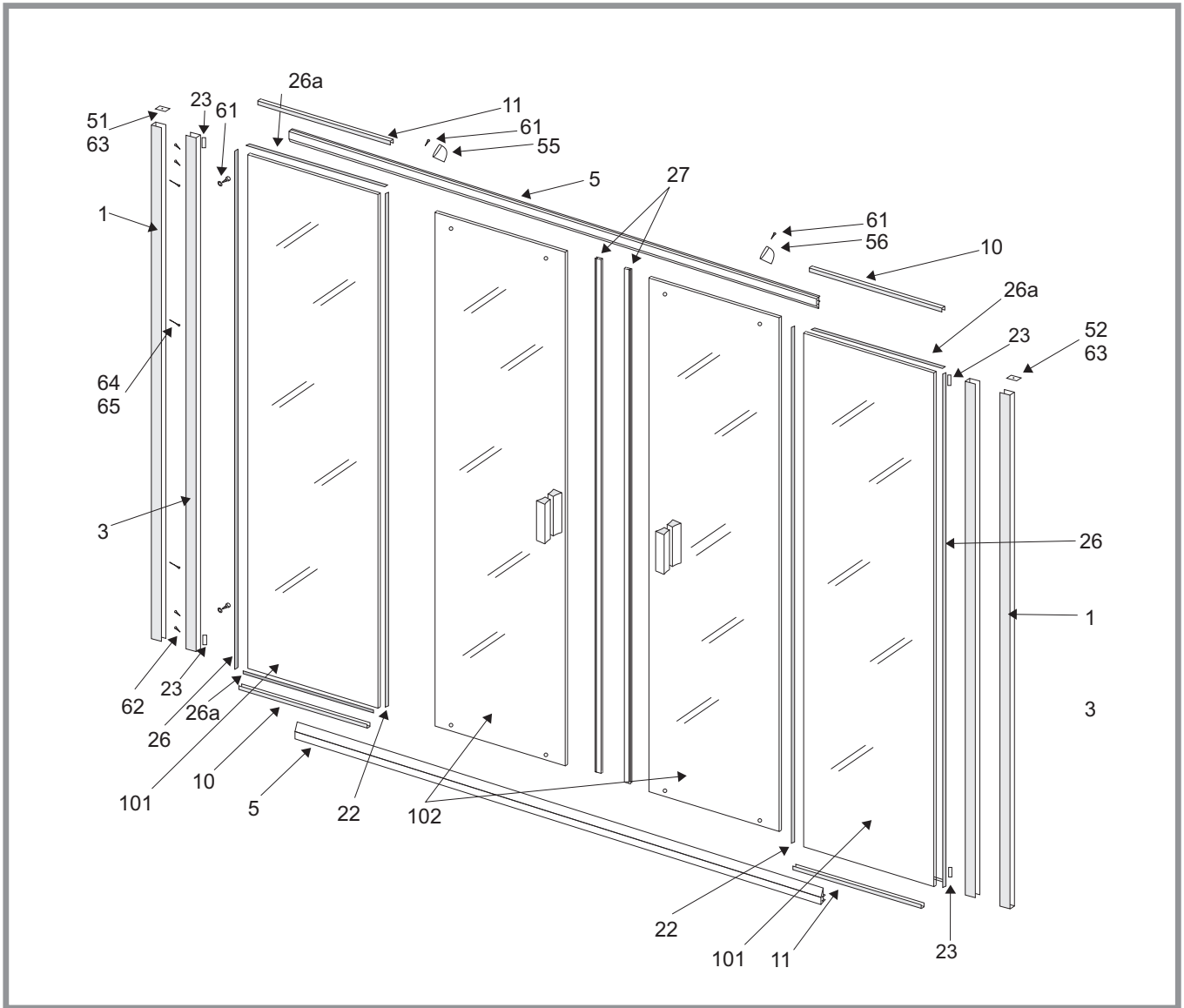



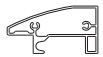





















RAPIER RDP4 - 120,130,140,150,160,170,180,190,200 - SATIN



RAPIER RDP4 - 120,130,140,150,160,170,180,190,200 - SATIN

Číslo dílu	Název dílu	Rozměr mm	Pro rozměr výrobku	SIČ	Typový díl pro všechny rozměry SIČ	
1	„U“ profil přímý	dl. 1900			XVRA0501X1900	
3	Svislý profil PD	dl. 1900			XVRA0302X1900	
5	Vodící profil	dl. 1058	RDP4-120	XVRA0137X1058		
		dl. 1158	RDP4-130	XVRA0138X1158		
		dl. 1258	RDP4-140	XVRA0139X1258		
		dl. 1358	RDP4-150	XVRA0127X1358		
		dl. 1458	RDP4-160	XVRA0128X1458		
		dl. 1558	RDP4-170	XVRA0129X1558		
		dl.1658	RDP4-180	XVRA0130X1658		
		dl. 1758	RDP4-190	XVRAO140X1758		
		dl. 1858	RDP4-200	XVRA0141X1858		
10	Lem skla	dl. 242	RDP4-120	XVRA0931X0242		
		dl. 267	RDP4-130	XVRA0933X0267		
		dl. 292	RDP4-140	XVRA0935X0292		
		dl. 317	RDP4-150	XVRA0911X0317		
		dl.342	RDP4-160	XVRA0913X0342		
		dl. 367	RDP4-170	XVRA0915X0367		
		dl. 392	RDP4-180	XVRA0917X0392		
		dl. 417	RDP4-190	XVRA0937X0417		
		dl. 442	RDP4-200	XVRA0939X0442		
11	Lem skla	dl. 242	RDP4- 120	XVRA0932X0242		
		dl. 267	RDP4-130	XVRA0934X0267		
		dl.292	RDP4-140	XVRA0936X0292		
		dl.317	RDP4-150	XVRA0912X0317		
		dl.342	RDP4-160	XVRA0914X0342		
		dl.367	RDP4-170	XVRA0916X0367		
		dl.392	RPD4-180	XVRA0918X0392		
		dl.417	RPD4-190	XVRA0938X0417		
		dl.442	RDP4-200	XVRA0940X0442		







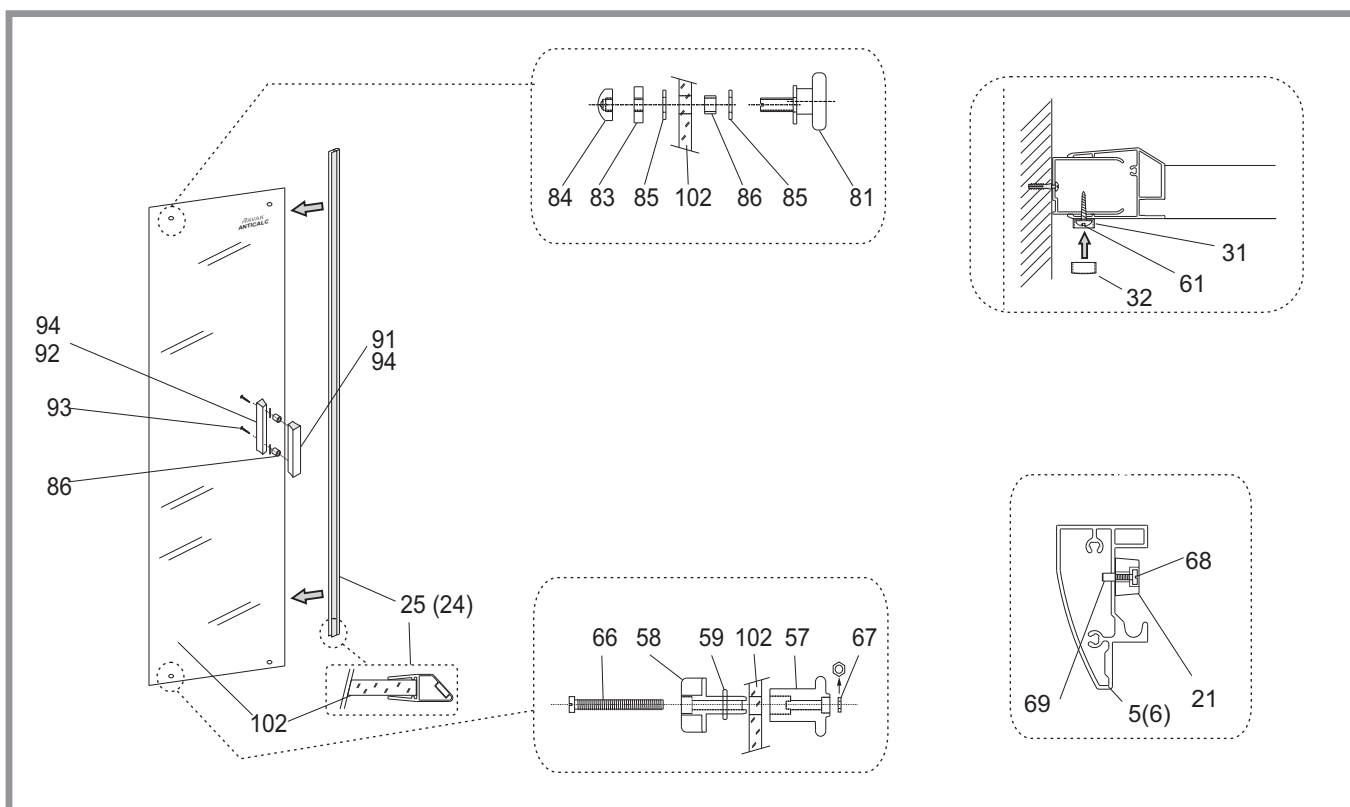
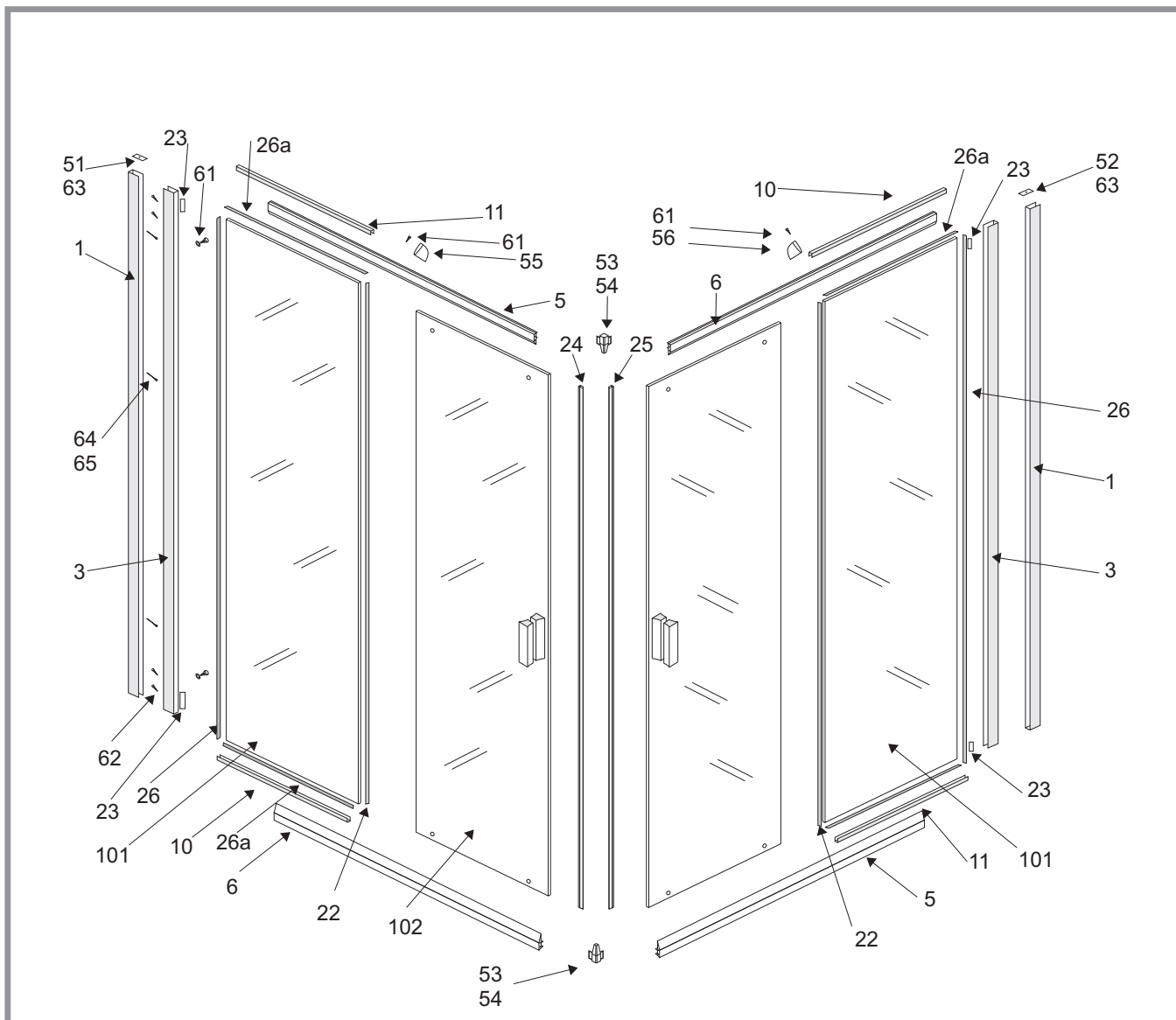















RAPIER RDP4 - 120,130,140,150,160,170,180,190,200 - SATIN

Číslo dílu	Název dílu	Rozměr mm	Pro rozměr výrobku	SIČ	Typový díl pro všechny rozměry SIČ	
21	Měkký doraz	ø 16			X88500000000	
22	Svislý těsnící profil 89	dl. 1800			X88900000000	
23	Profil měkk. dorazu 91	dl. 133			X89100000000	
26	Zasklívací profil 90	dl. 1815			X89000000000	
26a	Zasklívací profil 111	dl. 1200			X8B100000000	
27	Magnetický profil přímý	dl. 1882			X6C124600170	
31	Podložka krytky 106	ø 11			X8A600000000	
32	Krytka šedá	ø 11			X8A500000000	
33	Záslepka	ø 10			X80001100100	
51	Krytka ustav.profilu 78A				X878A0000000	
52	Krytka ustav.profilu 78B				X878B0000000	
55	Koncovka 84A				X884A0000000	
56	Koncovka 84B				X884B0000000	
57	Vodící háček 82				X88200000000	
58	Knoflík háčku 83				X88300000000	
59	„O“ kroužek	ø 16x2			X89000000004	
61	Šroub samoř.DIN 7981	ø 3,5x13			X97981035130	
62	Šroub samoř.DIN 7981	ø 3,5x25			X97981035250	
63	Šroub samoř.DIN 7982	ø 5x13			X97982035130	
64	Vruty do hmoždinky	ø 4x40			X94000040400	
65	Hmoždinka	ø 8			X20600080000	
66	Šroub nerez DIN 84	M 4x30			X90084040300	
67	Matice nerez/mosaz	M 4			X93000040025	
68	Šroub DIN 7985	M 4x16			X90085040160	
69	Nýtovací matice univ.	M 4			X 92010040000	
81	Ložisk. pojezd RAPIER	Jednoduchý			X3C0240304016	
83	Matice chrom	M 6x4			X3C0RAD02001A	
84	Krytka chrom	M 6x7			X3C0RAD02002A	
85	Podložka kolečka č. 87	ø 12,8x1,5			X88700000000	





RAPIER RKR2 - 80,90,100 - SATIN



RAPIER RKR2 - 80,90,100 - SATIN

Číslo dílu	Název dílu	Rozměr mm	Pro rozměr výrobku	SIČ	Typový díl pro všechny rozměry SIČ	
1	„U“ profil přímý	dl. 1900			XVRA0501X1900	
3	Svislý profil PD	dl. 1900			XVRA0301X1900	
5	Vodící profil	dl. 670	RKR2-80	XVRA0131X0670		
		dl. 770	RKR2-90	XVRA0133X0770		
		dl. 870	RKR2-100	XVRA0135X870		
6	Vodící profil	dl. 670	RKR2-80	XVRA0132X0670		
		dl. 770	RKR2-90	XVRA0134X0770		
		dl. 870	RKR2-100	XVRA0136X0870		
10	Lem skla	dl. 303	RKR2-80	XVRA0919X0303		
		dl. 353	RKR2-90	XVRA0921X0353		
		dl. 403	RKR2-100	XVRA0901X0403		
11	Lem skla	dl. 303	RKR2-80	XVRA0920X0303		
		dl. 353	RKR2-90	XVRA0922X0353		
		dl. 403	RKR2-100	XVRA0902X0403		
21	Měkký doraz 85CB	ø 16			X8850000000	
22	Svislý těsnící profil 89	dl. 1800			X8890000000	
23	Profil měkk. dorazu 91	dl. 133			X8910000000	
24	Magnet. profil šikmý L	dl. 1882	➤ pár		X6C124700170	
25	Magnet. profil šikmý P	dl. 1882			X6C124800170	
26	Zasklívací profil 90	dl. 3630			X8900000000	
26a	Zasklívací profil 111	dl. 1584			X8B10000000	
31	Podložka krytky 106	ø 11			X8A60000000	
32	Krytky šedá	ø 11			X8A50000000	
51	Krytka ustav.profilu 78A				X878A000000	
52	Krytka ustav.profilu 78B				X878B000000	
53	Rohový spoj 80 CB				X8800000000A	
54	Víčko rohového spoje				X8810000000A	
55	Koncovka 84 A				X884A000000	
56	Koncovka 84 B				X884B000000	







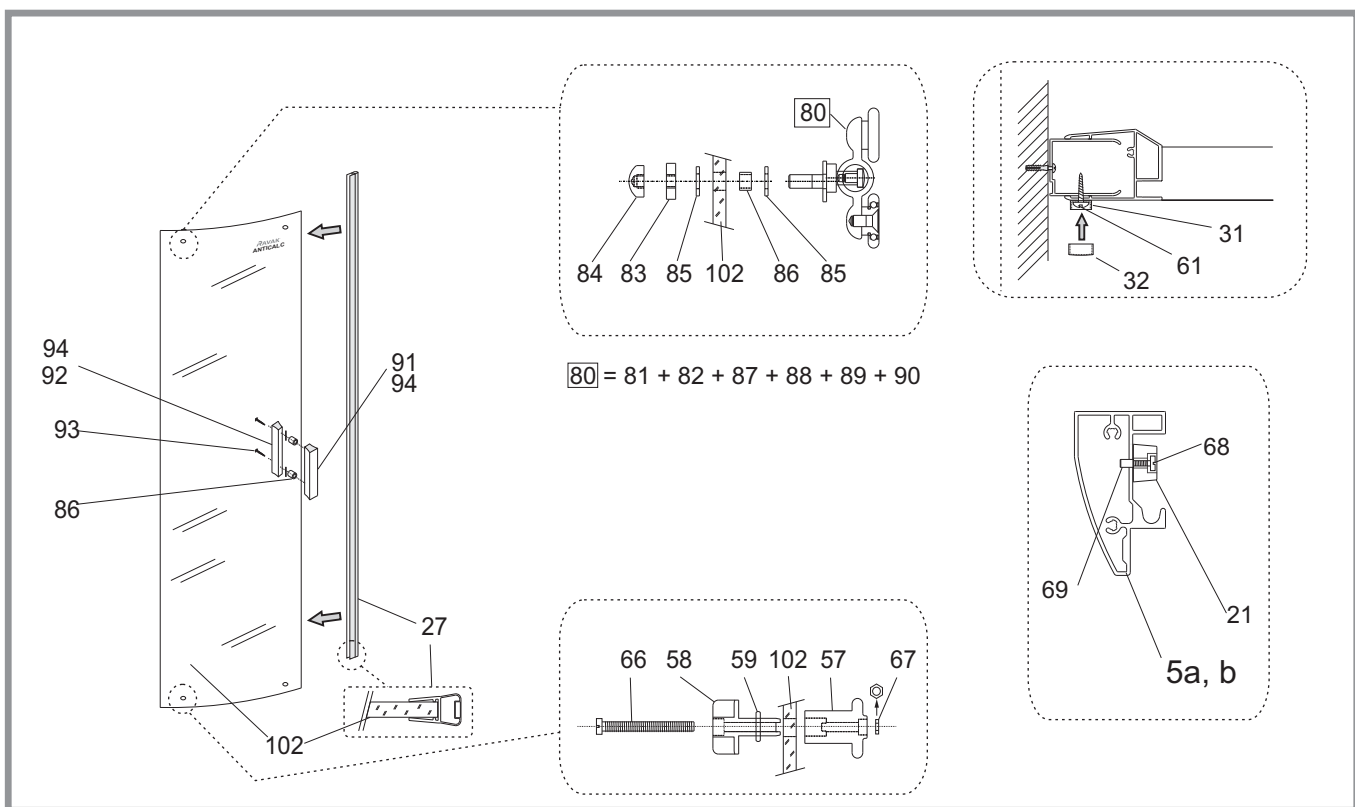
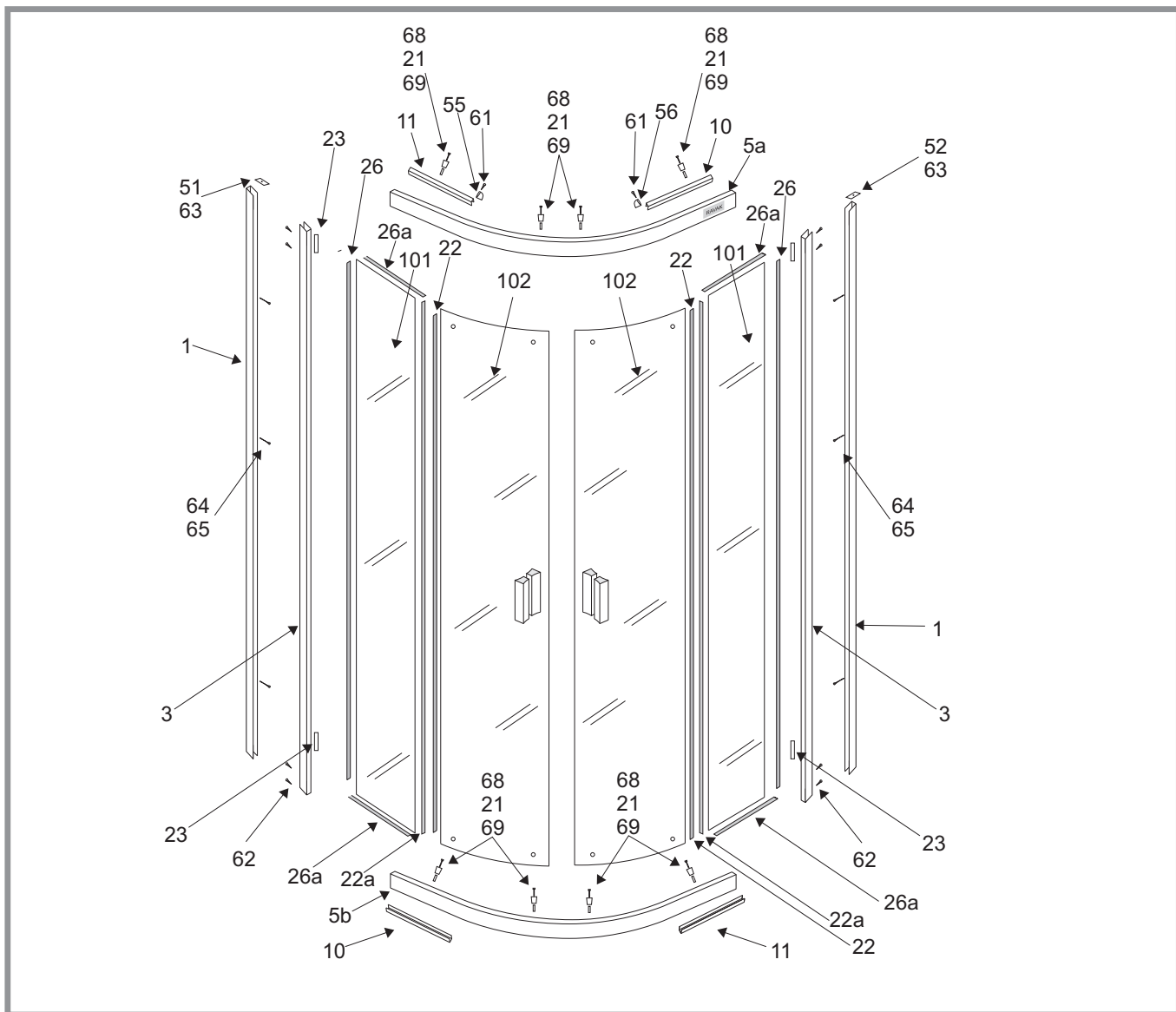





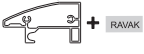

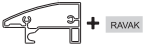

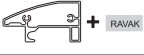







RAPIER RKR2 - 80,90,100 - SATIN

Číslo dílu	Název dílu	Rozměr mm	Pro rozměr výrobku	SIČ	Typový díl pro všechny rozměry SIČ	
57	Vodící háček 82				X8820000000	
58	Knoflík háčku 83				X8830000000	
59	„O“ kroužek	ø 16x2			X8900000004	
61	Šroub samoř DIN 7981	ø 3,5x13			X97981035130	
62	Šroub samoř DIN 7981	ø 3,5x25			X97981035250	
63	Šroub samoř DIN 7982	ø 3,5x13			X97982035130	
64	Vrut do hmoždinky	ø 4x40			X94000040400	
65	Hmoždinka	ø 8			X20600080000	
66	Šroub nerez DIN 84	M 4x30			X90084040300	
67	Matice nerez/mosaz	M 4			X93000040025	
68	Šroub DIN 7985	M 4x16			X90085040160	
69	Nýtovací matice univ.	M 4			X92010040000	
81	Ložisk. pojezd Rapier	jednoduchý			X3C0240304016	
83	Matice chrom	M 6x4			X3C0RAD02001A	
84	Krytka chrom	M 6x7			X3C0RAD02002A	
85	Podložka kolečka č. 87	ø 12,8x1,5			X88700000000	
86	Průchodka 88	ø 7,7x5,5			X88800000000	
91	Madlo RAPIER vnější Cr	dl. 165			XVB01601A0165	
92	Madlo RAPIER vnitřní Cr	dl. 165			XVB01602A0165	
93	Šroub DIN 964 nerez	M 4x35			X90964040350	
94	Podložka madla RAPIER				X3C0RAD030010	
101	Sklo PS tl. 6mm	1815x297	RKR2-80	X4Z160115297		
		1815x347	RKR2-90	X4Z160115347		
		1815x397	RKR2-100	X4Z160115397		
102	Sklo dveří tl. 6mm	1882x387	RKR2-80	X4Z160182387		
		1882x437	RKR2-90	X4Z160182437		
		1882x487	RKR2-100	X4Z160182487		

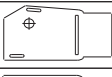









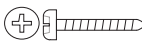
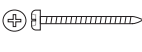
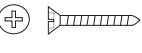
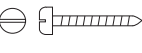
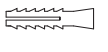
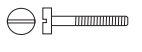

RAPIER RKCP4 - 80, 90, 100 - SATIN

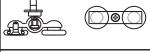

RAPIER RKCP4 - 80, 90, 100 - SATIN

Číslo dílu	Název dílu	Rozměr mm	Pro rozměr výrobku	SIČ	Typový díl pro všechny rozměry SIČ	
1	"U" profil přímý	dl. 1900			XVRA0501X1900	
3	Svislý profil PD	dl. 1900			XVRA0301X1900	
5a	Vodící profil horní	dl. 1190	RKCP4-80	XVRA0101X1190		
5b	Vodící profil spodní	dl. 1190	RKCP4-80	XVRA0143X1190		
5a	Vodící profil horní	dl. 1390	RKCP4-90	XVRA0102X1390		
5b	Vodící profil spodní	dl. 1390	RKCP4-90	XVRA0144X1390		
5a	Vodící profil horní	dl. 1590	PKCP4-100	XVRA0103X1590		
5b	Vodící profil spodní	dl. 1590	PKCP4-100	XVRA0145X1590		
10	Lem skla	dl. 231	RKCP4-80	XVRA0925X0231		
		dl. 331	RKCP4-90	XVRA0927X0331		
		dl. 431	RKCP4-100	XVRA0929X0431		
11	Lem skla	dl. 231	RKCP4-80	XVRA0926X0231		
		dl. 331	RKCP4-90	XVRA0928X0331		
		dl.431	RKCP4-100	XVRA0930X0431		
21	Měkký doraz 85CB	ø 16			X88500000000	
22	Svislý těsnící profil 92	dl. 1882			X89200000000	
22a	Svislý těsnící profil 93	dl.1800			X89300000000	
23	Profil měkk. dorazu 91	dl. 133			X89100000000	
26	Zasklívací profil 90	dl. 3630			X89000000000	
26a	Zasklívací profil 111	dl. 1700			X8B100000000	
27	Magnet. profil přímý	dl. 1882			X6C124600170	
31	Podložka krytky 106	ø 11			X8A600000000	
32	Krytka šedá	ø11			X8A500000000	
51	Krytka ustav.profilu 78A				X878A0000000	
52	Krytka ustav.profilu 78B				X878B0000000	
55	Koncovka 84 A				X884A0000000	
56	Koncovka 84 B				X884B0000000	
57	Vodící háček 86				X88600000000	
58	Knoflík háčku 83				X88300000000	

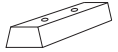
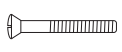
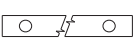





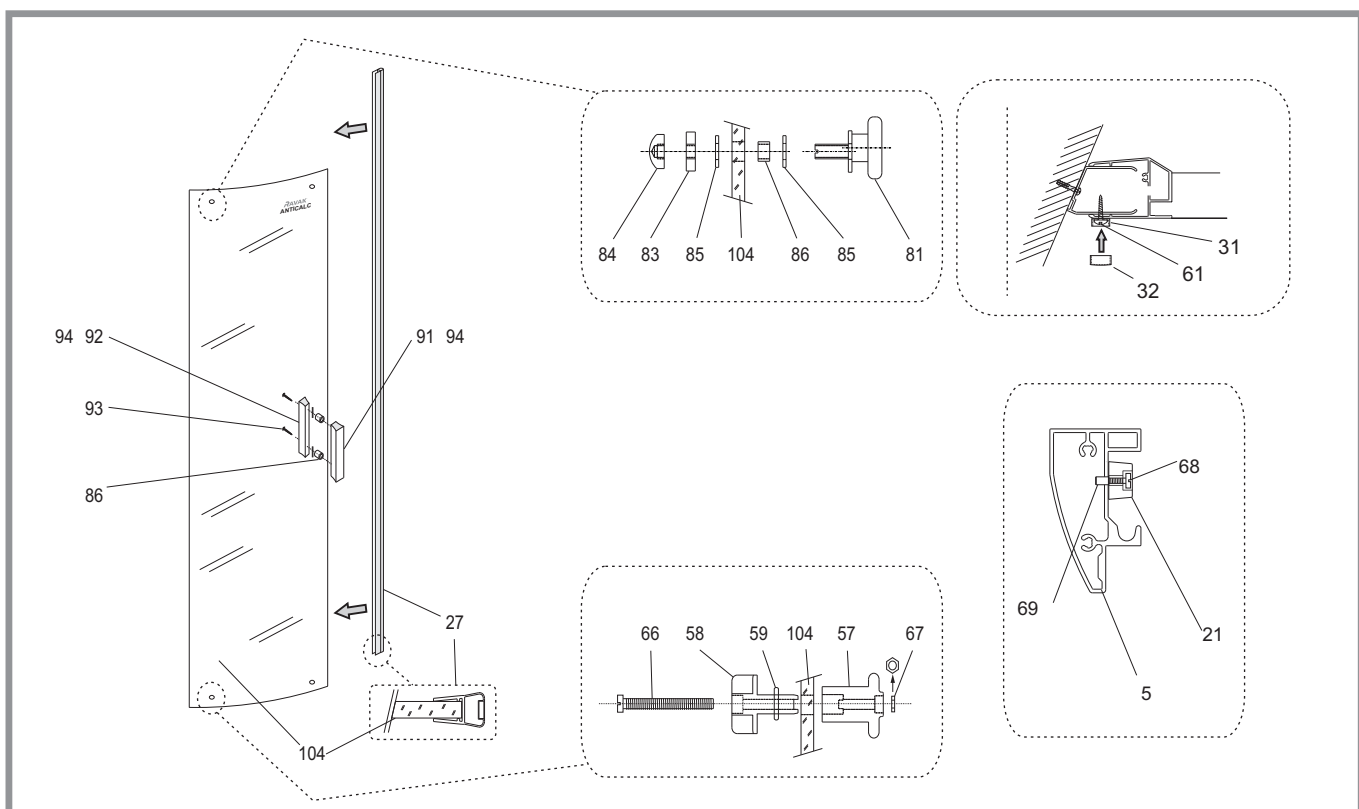
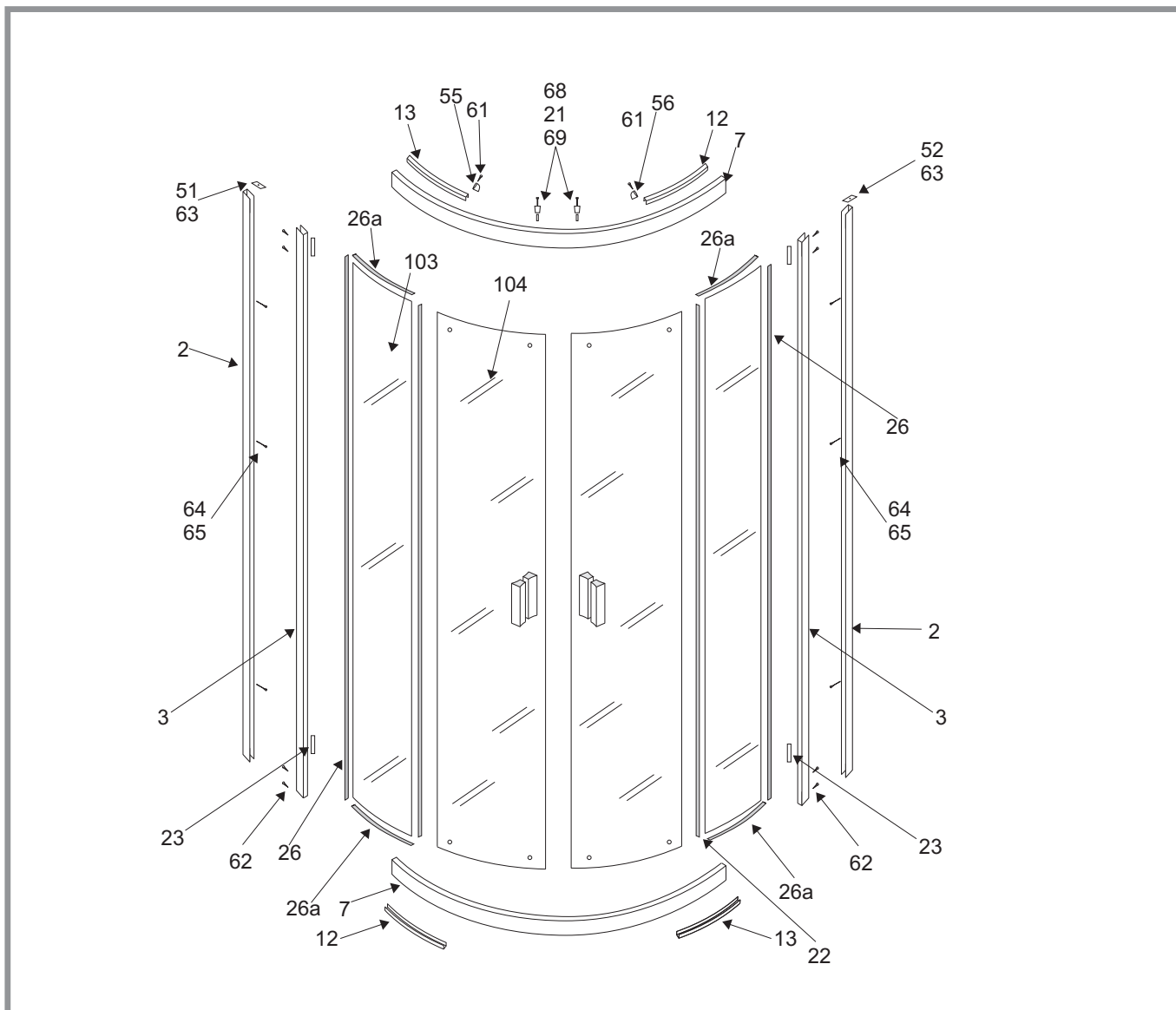



















RAPIER RKCP4 - 80, 90, 100 - SATIN

Číslo dílu	Název dílu	Rozměr mm	Pro rozměr výrobku	SIČ	Typový díl pro všechny rozměry SIČ	
59	"O" kroužek	∅ 16x2			X89000000004	
61	Šroub samoř.DIN 7981	∅ 3,5x13			X97981035130	
62	Šroub samoř.DIN 7981	∅ 3,5x25			X97981035250	
63	Šroub samoř.DIN 7982	∅ 3,5x13			X97982035130	
64	Vrut do hmoždinky	∅ 4x40			X94000040400	
65	Hmoždinka	∅ 8			X20600080000	
66	Šroub nerez DIN 84	M 4x40			X90084040400	
67	Matice nerez / mosaz	M 4			X93000040025	
68	Šroub DIN 7985	M 4x16			X90085040160	
69	Nýtovací matice univ.	M 4			X92010040000	
80	Ložisk.pojezd RAPIER	vyklápěcí	obsahuje díly 81, 82, 87, 88, 89, 90			
81	Kolečko dveří RKCP 4				X3CORAD010010	
82	Čep niklovaný				X3C0RAD010020	
83	Matice chrom	M 6x4			X3C0RAD02001A	
84	Krytka chrom	M 6x7			X3C0RAD02002A	
85	Podložka kolečka č.87	∅ 12,8x1,5			X88700000000	
86	Průchodka 88	∅ 7,7x5,5			X88800000000	
87	Váleček				X3C0RAD010030	
88	Nosič koleček				X3C0RAD010040	
89	Šroub DIN 7985	M 4x6			X90085040060	
90	Šroub DIN 7991	M 5x12			X90091050120	
91	Madlo RAPIER vnější Cr	dl. 165			XVB01601A0165	
92	Madlo RAPIER vnitřní Cr	dl. 165			XVB01602A0165	
93	Šroub DIN 964 nerez	M 4x35			X90964040350	
94	Podložka madla RAPIER				X3C0RAD030010	
101	Sklo PS tl. 6 mm	1815x225	RKCP4-80	X4Z160I15225		
		1815x325	RKCP4-90	X4Z160I15325		
		1815x425	RKCP4-100	X4Z160I15425		

RAPIER RKKP4 - 90 - SATIN





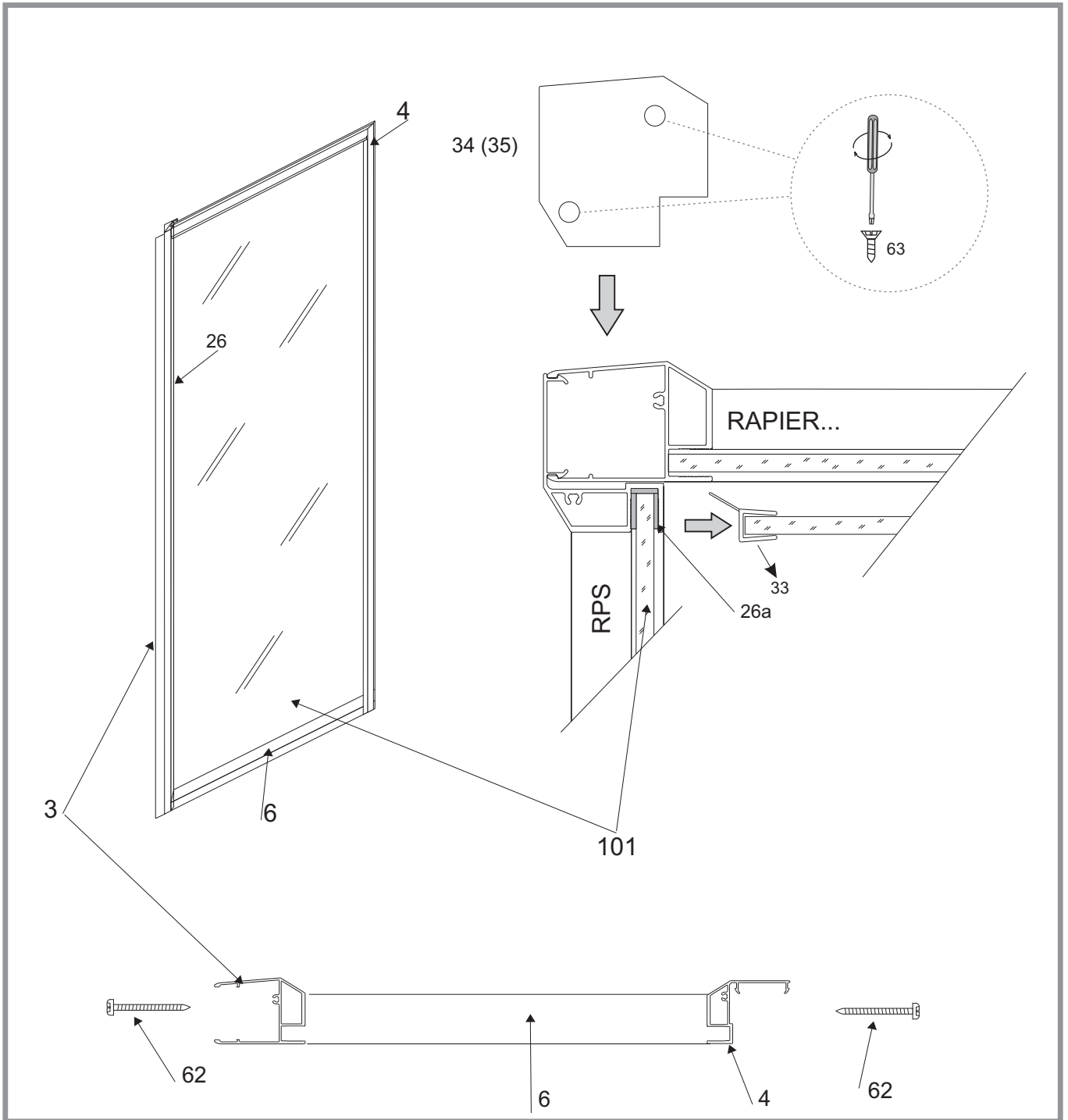

RAPIER RKKP4 - 90 - SATIN

Číslo dílu	Název dílu	Rozměr mm	Pro rozměr výrobku	SIČ	Typový díl pro všechny rozměry SIČ	
2	„U“ profil šikmý	dl. 1900		XVRA0801X1900		
3	Svislý profil PD	dl. 1900		XVRA0301X1900		
7	Vodící profil	dl. 1378		XVRA0104X1378		
12	Lem skla	dl. 303		XVRA0201X0303		
13	Lem skla	dl. 303		XVRA0202X0303		
21	Měkký doraz	ø 13		X88500000000		
22	Svislý těsnící profil 89	dl. 1800		X88900000000		
23	Profil měkk.dorazu 91	dl. 133		X89100000000		
26	Zasklívací profil 90	dl. 3630		X89000000000		
26a	Zasklívací profil 111	dl. 1180		X8B100000000		
27	Magnetický profil přímý	dl. 1882		X6C124600170		
31	Podložka krytky 106	ø 11		X8A600000000		
32	Krytka šedá	ø 11		X8A500000000		
51	Krytka ustav.profilu 78A			X878A0000000		
52	Krytka ustav.profilu 78B			X878B0000000		
55	Koncovka 84A			X884A0000000		
56	Koncovka 84B			X884B0000000		
57	Vodící háček 82			X88200000000		
58	Knoflík háčku 83			X88300000000		
59	„O“ kroužek	ø 16x2		X89000000004		
61	Šroub samoř.DIN 7981	ø 3,5x13		X97981035130		
62	Šroub samoř.DIN 7981	ø 3,5x25		X97981035250		
63	Šroub samoř.DIN 7982	ø 3,5x13		X97982035130		
64	Vrut do hmoždinky	ø 4x40		X94000040400		
65	Hmoždinka	ø 8		X20600080000		
66	Šroub nerez DIN 84	M 4x30		X90084040300		
67	Matice nerez/mosaz	M 4		X93000040025		





RAPIER RPS - 80,90,100 - SATIN



RAPIER kompletní pojezd jednoduchý**SIČ: D00000001**

Číslo dílu	Název dílu	Rozměr mm	SIČ	
81	Ložisk. pojezd RAPIER	Jednoduchý	X3C0240304016	
83	Matice chrom	M 6 x 4	X3C0RAD02001A	
84	Krytka chrom	M 6 x 7	X3C0RAD02002A	
85	Podložka kolečka č.87	∅12,8x1,5	X88700000000	
86	Průchodka 88	∅7,7x5,5	X88800000000	

RAPIER kompletní vodící háček 82 (krátký)**SIČ: D000001022**





Číslo dílu	Název dílu	Rozměr mm	SIČ	
57	Vodící háček 82		X88200000000	
58	Knoflík háčku 83		X88300000000	
59	„O“ kroužek	∅16 x 2	X89000000004	
66	Šroub nerez DIN 84	M 4 x 30	X90084040300	
67	Matice nerez/mosaz	M 4	X93000040025	

Platí pro všechny výrobky RAPIER kromě RKCP4 a RPS

RAPIER kompletní pojezd vyklápěcí**SIČ: D00000002**

Číslo dílu	Název dílu	Rozměr mm	SIČ	
81	Kolečko dveří RKCP 4		X3CORAD010010	
82	Čep niklovaný		X3C0RAD010020	
83	Matice chrom	M 6x4	X3C0RAD02001A	
84	Krytka chrom	M 6x7	X3C0RAD02002A	
85	Podložka kolečka č.87	ø 12,8x1,5	X88700000000	
86	Průchodka 88	ø 7,7x5,5	X88800000000	
87	Váleček		X3C0RAD010030	
88	Nosič koleček		X3C0RAD010040	
89	Šroub DIN 7985	M 4x6	X90085040060	
90	Šroub DIN 7991	M 5x12	X90091050120	

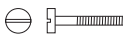
RAPIER kompletní vodící háček 86 (dlouhý)**SIČ: D000001023**

Číslo dílu	Název dílu	Rozměr mm	SIČ	
57	Vodící háček 86		X88600000000	
58	Knoflík háčku 83		X88300000000	
59	„O“ kroužek	ø 16 x 2	X89000000004	
66	Šroub nerez DIN 84	M 4 x 40	X90084040400	
67	Matice nerez/mosaz	M 4	X93000040025	

Platí pouze pro RKCP4

RAVAK a.s., Obecnická 285, 261 01 Příbram I, ČR
tel.: +420 318 427 111, fax: +420 318 427 278. e-mail: info@ravak.cz, www.ravak.cz

RAVAK SLOVAKIA spol. s r.o., Einsteinová 11, 851 01 Bratislava
tel.: 02 444 550 01, fax: 02 444 550 02, e-mail: obchod@ravak.sk, www.ravak.sk

RAVAK POLSKA s.a., Kałęczyn 2B., ul. Radziejowicka 124, 05-825 Grodzisk Mazowiecki, POLSKA
tel.: 22 / 755 40 30, fax: 22 / 755 43 90, e-mail: info@ravak.pl, www.ravak.pl

RAVAK Hungary Kft., 1142 Budapest, Erzsébet királyné útja 125, HUNGARY
tel.: 06 (1) 223 13 15, 06 (1) 223 13 16, fax: 06 (1) 223 13 14, e-mail: info@ravak.hu, www.ravak.hu

Ravak Gesellschaft für Sanitärprodukte mbH, Alexanderstrasse 58, D - 45472 Mülheim an der Ruhr
Tel. (0208) 37789-30 Fax. (0208) 37789-55, www.ravak.de, e-mail: info@ravak.de

RAVAK a.s., Representative Office in Ukraine, 21 Dniprovska Naberezhna str., 2nd floor, 02081, Kyiv, Ukraine
tel.: 00380 44 2203232, 00380 44 3605200, fax: 00380 44 2204343, e-mail: ravak@ravak.kiev.ua, web: www.ravak.ua

OOO RAVAK ru, ul. Staropetrovskiy pr. 7A, Moskva 125 130,
tel./fax: 007 495 710 82 23, 007 495 450 12 77, e-mail: ravak@inbox.ru, www.ravak.com

RAVAK®

RAVAK a.s., Obecnická 285, 261 01 Příbram I
tel.: +420 318 427 200, 318 427 111 fax: +420 318 427 269
e-mail: info@ravak.cz, www.ravak.com

Výrobce si vyhrazuje právo změny ceny, technických parametrů, či dalších skutečností bez předchozího upozornění a nenese odpovědnost za tiskové chyby.